

DUNBAR 100 LED

astro

GENERAL

LOCATION:	Exterior
CLASS:	CE (Class I)
IP RATING:	IP65
BATHROOM ZONE:	Zone 1, 2, 3
DRIVER REQUIRED:	No
INSTALLATION ORIENTATION:	Wall Mount - Down or Uplight
MAIN MATERIAL:	Metal - Aluminium
DIMENSIONS (mm):	H: 100 W: 80 D: 100
CUT OUT HOLE (mm):	-
RECESS DEPTH (mm):	-
FIRE RATING:	-
CABLE LENGTH (mm):	-
GROSS WEIGHT (kg):	0.72

LAMP

LIGHT SOURCE:	High Powered LED
WATTAGE:	3.7W
LAMP INCLUDED:	Yes (Integral)
MAXIMUM LAMP LENGTH (mm):	-
LUMINOUS FLUX (lm):	64
COLOUR TEMP (K):	3000
CRI (Ra):	90
MACADAM ELLIPSE:	3-Step
TILT ADJUSTABLE ANGLE (°):	-
ROTATION ADJUSTABLE ANGLE (°):	-
LIFETIME (hrs):	60000
BEAM ANGLE (°):	To Be Advised

ELECTRICAL

SWITCHED:	No
DIMMABLE:	No
DIMMING METHOD:	-
SUPPLY FREQUENCY (Hz):	50/60
DRIVER/BALLAST VOLTAGE (V):	220-240
DRIVER LIFETIME (hrs):	60000
EFFICACY (lm/W):	17

ADDITIONAL INFORMATION:

SHADE INCLUDED:	-
SHADE/DIFFUSER MATERIAL:	Glass
SHADE/DIFFUSER FINISH	Clear
F MARK:	Suitable for mounting on flammable materials



CODE: 1384001
FINISH: TEXTURED WHITE

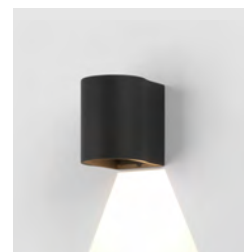

CODE: 1384003
FINISH: TEXTURED BLACK

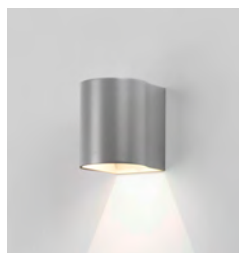

CODE: 1384022
FINISH: TEXTURED GREY

TO MAINTAIN THIS PRODUCT TO ITS BEST CONDITION, PLEASE VIEW OUR CARE AND CLEANING GUIDE ON THE SUPPORT SECTION OF THE ASTRO WEBSITE.

Pour entretenir au mieux ce produit, veuillez consulter notre guide d'entretien et de nettoyage, dans la rubrique d'aide sur le site Web d'Astro.

Um dieses Produkt im besten Zustand zu erhalten, beachten Sie bitte unseren Leitfaden zu Pflege und Reinigung im Abschnitt „Support“ auf der Astro-Website.

Per mantenere questo prodotto nelle sue migliori condizioni, consultare la nostra guida per la manutenzione e la pulizia nella sezione dedicata all'assistenza del sito Web Astro.

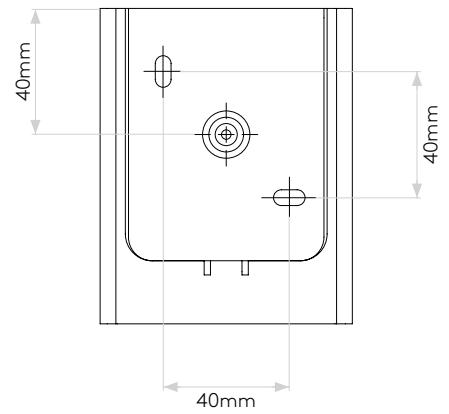
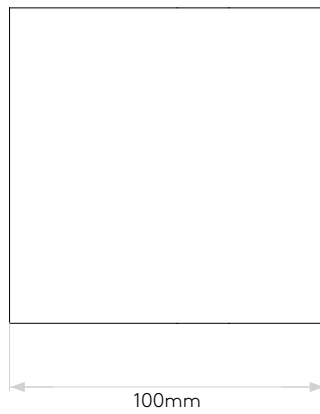
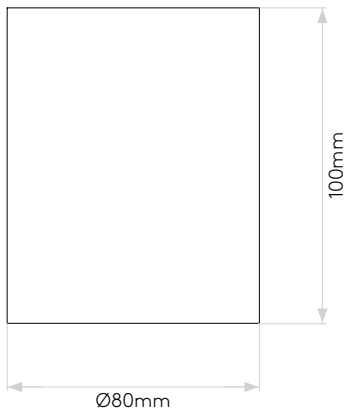
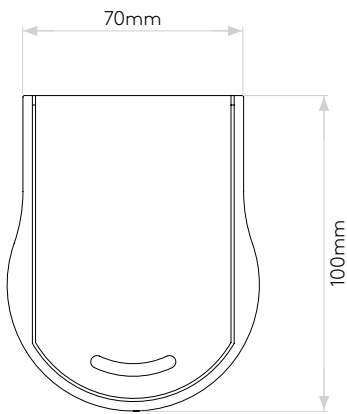

Please note that some dimensions may vary slightly due to manufacturing tolerances, this includes cable entry and fixing holes

Veuillez noter que certaines dimensions peuvent varier légèrement en raison des tolérances de fabrication, y compris l'entrée de câble et les trous de fixation.

Bitte beachten Sie, dass die Maße Fertigungstoleranzen unterliegen und daher in geringem Umfang von der angegebenen Größe abweichen können. Dies gilt auch für Kabeleingänge und Befestigungslöcher.

Si prega notare che possono esserci piccole variazioni in alcune dimensioni dovute alle tolleranze di produzione, queste includono l'ingresso del cavo e i fori di fissaggio.

DUNBAR 120

astro

GENERAL

LOCATION:	Exterior
CLASS:	CE (Class I)
IP RATING:	IP65
BATHROOM ZONE:	Zone 1, 2, 3
DRIVER REQUIRED:	No
INSTALLATION ORIENTATION:	Wall Mount - Vertical
MAIN MATERIAL:	Concrete - Cast
DIMENSIONS (mm):	H: 120 W: 94 D: 109
CUT OUT HOLE (mm):	-
RECESS DEPTH (mm):	-
FIRE RATING:	-
CABLE LENGTH (mm):	-
GROSS WEIGHT (kg):	1.3

LAMP

LIGHT SOURCE:	High Powered LED
WATTAGE:	3.9W
LAMP INCLUDED:	Yes (Integral)
MAXIMUM LAMP LENGTH (mm):	-
LUMINOUS FLUX (lm):	60
COLOUR TEMP (K):	3000
CRI (Ra):	90
MACADAM ELLIPSE:	3-Step
TILT ADJUSTABLE ANGLE (°):	-
ROTATION ADJUSTABLE ANGLE (°):	-
LIFETIME (hrs):	60000
BEAM ANGLE (°):	47

ELECTRICAL

SWITCHED:	No
DIMMABLE:	No
DIMMING METHOD:	-
SUPPLY FREQUENCY (Hz):	50/60
DRIVER/BALLAST VOLTAGE (V):	220-240
DRIVER LIFETIME (hrs):	60000
EFFICACY (lm/W):	15

ADDITIONAL INFORMATION:

SHADE INCLUDED:	-
SHADE/DIFFUSER MATERIAL:	Glass
SHADE/DIFFUSER FINISH	Clear
F MARK:	Suitable for mounting on flammable materials



CODE: 1384019 (8186)
FINISH: CONCRETE

THIS PRODUCT IS SUITABLE FOR USE BY THE COAST AND OTHER ONEROUS ENVIRONMENTS – TEN YEAR WARRANTY APPLIES, EXCEPT WHEN THE PRODUCT HAS AN INTEGRAL LED AND/OR DRIVER IN WHICH CASE, A THREE YEAR WARRANTY APPLIES. FOR FURTHER WARRANTY INFORMATION PLEASE REFER BACK TO THE ORIGINAL POINT OF PURCHASE.

Ce produit peut être utilisé à proximité des côtes et en environnements difficiles. Il bénéficie d'une garantie de dix ans, sauf s'il est équipé d'une LED et/ou d'un driver intégré(e), auquel cas il bénéficie d'une garantie de trois ans. Pour obtenir de plus amples informations au sujet de la garantie, veuillez vous adresser au point de vente initial.

Dieses Produkt ist für den Einsatz an der Küste und in anderen anspruchsvollen Umgebungen geeignet – es gilt eine zehnjährige Garantie, außer, wenn das Produkt eine integrierte LED und/oder einen integrierten Treiber hat. In diesem Fall gilt eine dreijährige Garantie. Für weitere Informationen zur Garantie wenden Sie sich bitte an die ursprüngliche Verkaufsstelle.

Questo prodotto è adatto per l'uso in zone costiere e in altri ambienti gravosi ed è coperto da una garanzia decennale, tranne quando il prodotto è dotato di un LED integrato e/o di un driver, nel qual caso è coperto da una garanzia triennale. Per ulteriori informazioni sulla garanzia, fare riferimento al centro di acquisto originale.

TO MAINTAIN THIS PRODUCT TO ITS BEST CONDITION, PLEASE VIEW OUR CARE AND CLEANING GUIDE ON THE SUPPORT SECTION OF THE ASTRO WEBSITE.

Pour entretenir au mieux ce produit, veuillez consulter notre guide d'entretien et de nettoyage, dans la rubrique d'aide sur le site Web d'Astro.

Um dieses Produkt im besten Zustand zu erhalten, beachten Sie bitte unseren Leitfaden zu Pflege und Reinigung im Abschnitt „Support“ auf der Astro-Website.

Per mantenere questo prodotto nelle sue migliori condizioni, consultare la nostra guida per la manutenzione e la pulizia nella sezione dedicata all'assistenza del sito Web Astro.

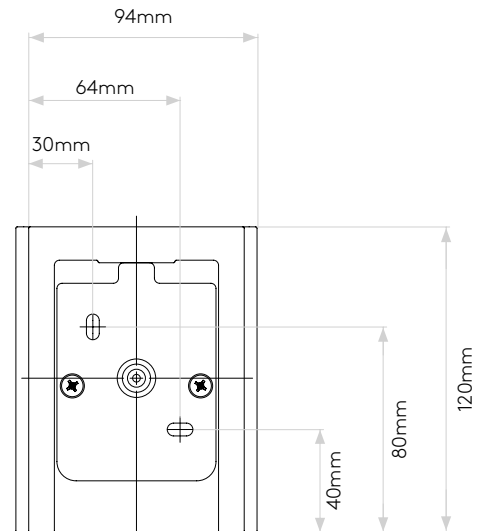
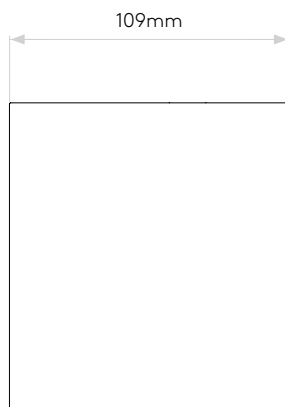
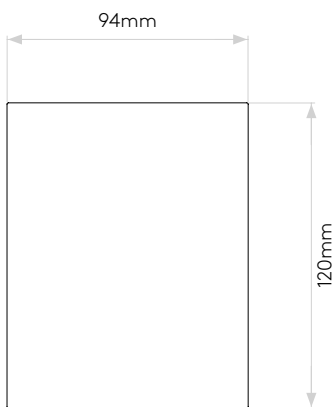
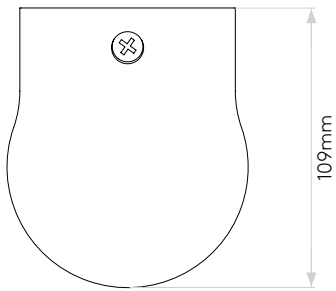

Please note that some dimensions may vary slightly due to manufacturing tolerances, this includes cable entry and fixing holes

Veuillez noter que certaines dimensions peuvent varier légèrement en raison des tolérances de fabrication, y compris l'entrée de câble et les trous de fixation.

Bitte beachten Sie, dass die Maße Fertigungstoleranzen unterliegen und daher in geringem Umfang von der angegebenen Größe abweichen können. Dies gilt auch für Kabeleingänge und Befestigungslöcher.

Si prega notare che possono esserci piccole variazioni in alcune dimensioni dovute alle tolleranze di produzione, queste includono l'ingresso del cavo e i fori di fissaggio.

DUNBAR 160 LED

astro

GENERAL

LOCATION:	Exterior
CLASS:	CE (Class I)
IP RATING:	IP65
BATHROOM ZONE:	Zone 1, 2, 3
DRIVER REQUIRED:	No
INSTALLATION ORIENTATION:	Wall Mount
MAIN MATERIAL:	Metal - Aluminium
DIMENSIONS (mm):	H: 160 W: 80 D: 100
CUT OUT HOLE (mm):	-
RECESS DEPTH (mm):	-
FIRE RATING:	-
CABLE LENGTH (mm):	-
GROSS WEIGHT (kg):	0.9

LAMP

LIGHT SOURCE:	High Powered LED
WATTAGE:	6.8W
LAMP INCLUDED:	Yes (Integral)
MAXIMUM LAMP LENGTH (mm):	-
LUMINOUS FLUX (lm):	134
COLOUR TEMP (K):	3000
CRI (Ra):	90
MACADAM ELLIPSE:	3-Step
TILT ADJUSTABLE ANGLE (°):	-
ROTATION ADJUSTABLE ANGLE (°):	-
LIFETIME (hrs):	60000
BEAM ANGLE (°):	To Be Advised

ELECTRICAL

SWITCHED:	No
DIMMABLE:	No
DIMMING METHOD:	-
SUPPLY FREQUENCY (Hz):	50/60
DRIVER/BALLAST VOLTAGE (V):	220-240
DRIVER LIFETIME (hrs):	60000
EFFICACY (lm/W):	20

ADDITIONAL INFORMATION:

SHADE INCLUDED:	-
SHADE/DIFFUSER MATERIAL:	Glass
SHADE/DIFFUSER FINISH	Clear
F MARK:	Suitable for mounting on flammable materials



CODE: 1384002
FINISH: TEXTURED WHITE

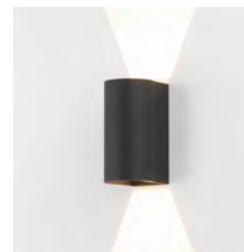

CODE: 1384004
FINISH: TEXTURED BLACK

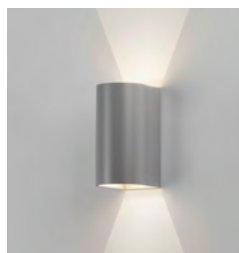

CODE: 1384009
FINISH: TEXTURED GREY

TO MAINTAIN THIS PRODUCT TO ITS BEST CONDITION, PLEASE VIEW OUR CARE AND CLEANING GUIDE ON THE SUPPORT SECTION OF THE ASTRO WEBSITE.

Pour entretenir au mieux ce produit, veuillez consulter notre guide d'entretien et de nettoyage, dans la rubrique d'aide sur le site Web d'Astro.

Um dieses Produkt im besten Zustand zu erhalten, beachten Sie bitte unseren Leitfaden zu Pflege und Reinigung im Abschnitt „Support“ auf der Astro-Website.

Per mantenere questo prodotto nelle sue migliori condizioni, consultare la nostra guida per la manutenzione e la pulizia nella sezione dedicata all'assistenza del sito Web Astro.

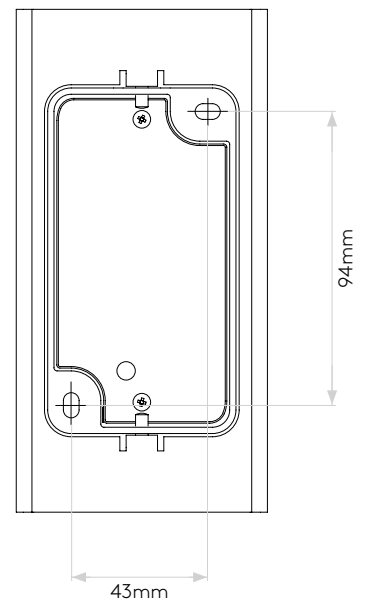
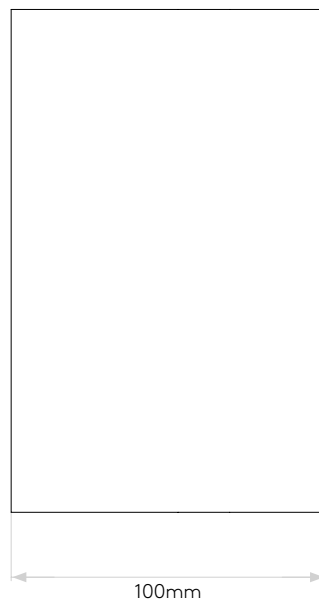
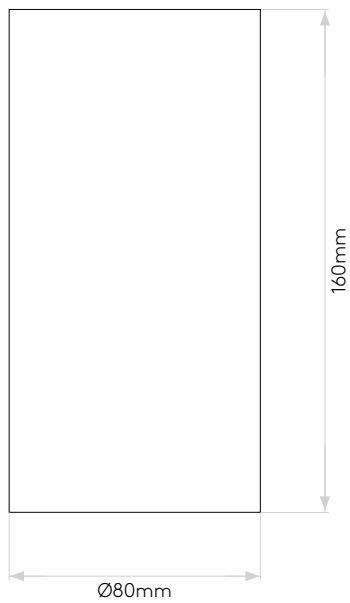
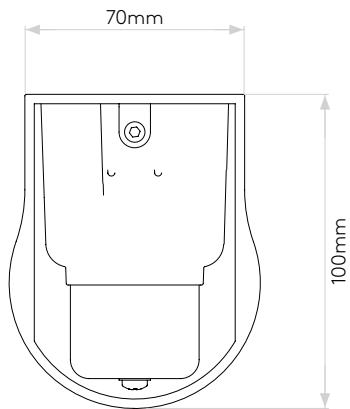

Please note that some dimensions may vary slightly due to manufacturing tolerances, this includes cable entry and fixing holes

Veuillez noter que certaines dimensions peuvent varier légèrement en raison des tolérances de fabrication, y compris l'entrée de câble et les trous de fixation.

Bitte beachten Sie, dass die Maße Fertigungstoleranzen unterliegen und daher in geringem Umfang von der angegebenen Größe abweichen können. Dies gilt auch für Kabeleingänge und Befestigungslöcher.

Si prega notare che possono esserci piccole variazioni in alcune dimensioni dovute alle tolleranze di produzione, queste includono l'ingresso del cavo e i fori di fissaggio.

DUNBAR 160

astro

GENERAL

LOCATION:	Exterior
CLASS:	CE (Class I)
IP RATING:	IP65
BATHROOM ZONE:	Zone 1, 2, 3
DRIVER REQUIRED:	No
INSTALLATION ORIENTATION:	Wall Mount - Vertical
MAIN MATERIAL:	Concrete Cast
DIMENSIONS (mm):	H: 160 W: 94 D: 107
CUT OUT HOLE (mm):	-
RECESS DEPTH (mm):	-
FIRE RATING:	-
CABLE LENGTH (mm):	-
GROSS WEIGHT (kg):	1.45

LAMP

LIGHT SOURCE:	High Powered LED
WATTAGE:	6.1W
LAMP INCLUDED:	Yes (Integral)
MAXIMUM LAMP LENGTH (mm):	-
LUMINOUS FLUX (lm):	115
COLOUR TEMP (K):	3000
CRI (Ra):	90
MACADAM ELLIPSE:	3-Step
TILT ADJUSTABLE ANGLE (°):	-
ROTATION ADJUSTABLE ANGLE (°):	-
LIFETIME (hrs):	60000
BEAM ANGLE (°):	47

ELECTRICAL

SWITCHED:	No
DIMMABLE:	No
DIMMING METHOD:	-
SUPPLY FREQUENCY (Hz):	50/60
DRIVER/BALLAST VOLTAGE (V):	220-240
DRIVER LIFETIME (hrs):	60000
EFFICACY (lm/W):	19

ADDITIONAL INFORMATION:

SHADE INCLUDED:	-
SHADE/DIFFUSER MATERIAL:	Glass
SHADE/DIFFUSER FINISH:	Clear
F MARK:	To Be Advised



CODE: 1384020 (8187)
FINISH: MATT CONCRETE

THIS PRODUCT IS SUITABLE FOR USE BY THE COAST AND OTHER ONEROUS ENVIRONMENTS – TEN YEAR WARRANTY APPLIES, EXCEPT WHEN THE PRODUCT HAS AN INTEGRAL LED AND/OR DRIVER IN WHICH CASE, A THREE YEAR WARRANTY APPLIES. FOR FURTHER WARRANTY INFORMATION PLEASE REFER BACK TO THE ORIGINAL POINT OF PURCHASE.

Ce produit peut être utilisé à proximité des côtes et en environnements difficiles. Il bénéficie d'une garantie de dix ans, sauf s'il est équipé d'une LED et/ou d'un driver intégré(e), auquel cas il bénéficie d'une garantie de trois ans. Pour obtenir de plus amples informations au sujet de la garantie, veuillez vous adresser au point de vente initial.

Dieses Produkt ist für den Einsatz an der Küste und in anderen anspruchsvollen Umgebungen geeignet – es gilt eine zehnjährige Garantie, außer, wenn das Produkt eine integrierte LED und/oder einen integrierten Treiber hat. In diesem Fall gilt eine dreijährige Garantie. Für weitere Informationen zur Garantie wenden Sie sich bitte an die ursprüngliche Verkaufsstelle.

Questo prodotto è adatto per l'uso in zone costiere e in altri ambienti gravosi ed è coperto da una garanzia decennale, tranne quando il prodotto è dotato di un LED integrato e/o di un driver, nel qual caso è coperto da una garanzia triennale. Per ulteriori informazioni sulla garanzia, fare riferimento al centro di acquisto originale.

TO MAINTAIN THIS PRODUCT TO ITS BEST CONDITION, PLEASE VIEW OUR CARE AND CLEANING GUIDE ON THE SUPPORT SECTION OF THE ASTRO WEBSITE.

Pour entretenir au mieux ce produit, veuillez consulter notre guide d'entretien et de nettoyage, dans la rubrique d'aide sur le site Web d'Astro.

Um dieses Produkt im besten Zustand zu erhalten, beachten Sie bitte unseren Leitfaden zu Pflege und Reinigung im Abschnitt „Support“ auf der Astro-Website.

Per mantenere questo prodotto nelle sue migliori condizioni, consultare la nostra guida per la manutenzione e la pulizia nella sezione dedicata all'assistenza del sito Web Astro.

PRODUCT ELEVATIONS

astro

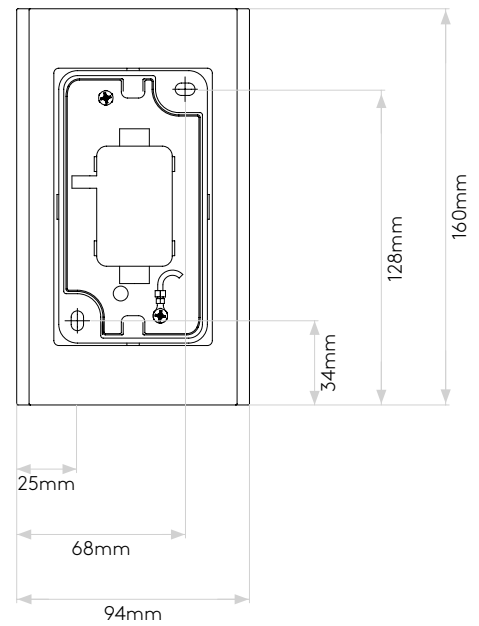
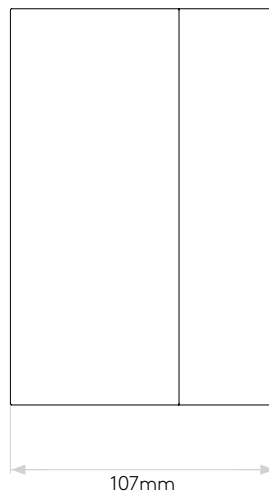
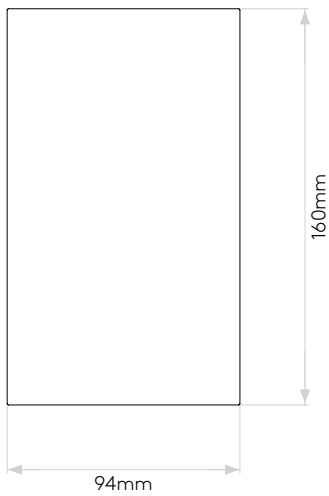
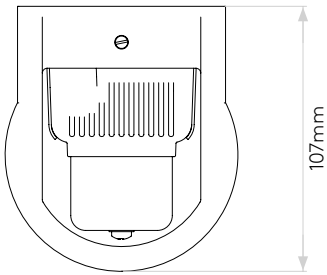

Please note that some dimensions may vary slightly due to manufacturing tolerances, this includes cable entry and fixing holes

Veuillez noter que certaines dimensions peuvent varier légèrement en raison des tolérances de fabrication, y compris l'entrée de câble et les trous de fixation.

Bitte beachten Sie, dass die Maße Fertigungstoleranzen unterliegen und daher in geringem Umfang von der angegebenen Größe abweichen können. Dies gilt auch für Kabeleingänge und Befestigungslöcher.

Si prega notare che possono esserci piccole variazioni in alcune dimensioni dovute alle tolleranze di produzione, queste includono l'ingresso del cavo e i fori di fissaggio.

DUNBAR 255 LED

astro

GENERAL

LOCATION:	Exterior
CLASS:	CE (Class I)
IP RATING:	IP65
BATHROOM ZONE:	Zone 1, 2, 3
DRIVER REQUIRED:	No
INSTALLATION ORIENTATION:	Wall Mount
MAIN MATERIAL:	Metal - Aluminium
DIMENSIONS (mm):	H: 255 W: 104 D: 125
CUT OUT HOLE (mm):	-
RECESS DEPTH (mm):	-
FIRE RATING:	-
CABLE LENGTH (mm):	-
GROSS WEIGHT (kg):	1.46

LAMP

LIGHT SOURCE:	COB LED
WATTAGE:	7.9W
LAMP INCLUDED:	Yes (Integral)
MAXIMUM LAMP LENGTH (mm):	-
LUMINOUS FLUX (lm):	365
COLOUR TEMP (K):	3000
CRI (Ra):	80
MACADAM ELLIPSE:	3-Step
TILT ADJUSTABLE ANGLE (°):	-
ROTATION ADJUSTABLE ANGLE (°):	-
LIFETIME (hrs):	36300
BEAM ANGLE (°):	To Be Advised

ELECTRICAL

SWITCHED:	No
DIMMABLE:	No
DIMMING METHOD:	-
SUPPLY FREQUENCY (Hz):	50/60
DRIVER/BALLAST VOLTAGE (V):	100-240
DRIVER LIFETIME (hrs):	-
EFFICACY (lm/W):	46

ADDITIONAL INFORMATION:

SHADE INCLUDED:	-
SHADE/DIFFUSER MATERIAL:	-
SHADE/DIFFUSER FINISH	-
F MARK:	Suitable for mounting on flammable materials

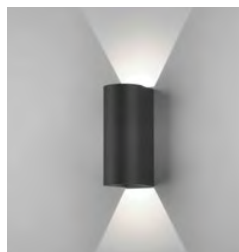

CODE: 1384005
FINISH: TEXTURED BLACK

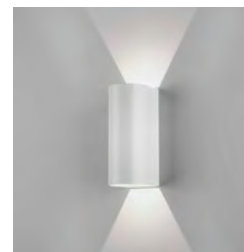

CODE: 1384007
FINISH: TEXTURED WHITE

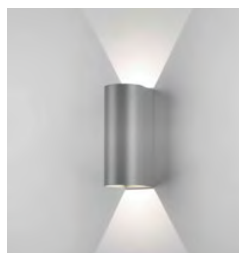

CODE: 1384021
FINISH: TEXTURED GREY

TO MAINTAIN THIS PRODUCT TO ITS BEST CONDITION, PLEASE VIEW OUR CARE AND CLEANING GUIDE ON THE SUPPORT SECTION OF THE ASTRO WEBSITE.

Pour entretenir au mieux ce produit, veuillez consulter notre guide d'entretien et de nettoyage, dans la rubrique d'aide sur le site Web d'Astro.

Um dieses Produkt im besten Zustand zu erhalten, beachten Sie bitte unseren Leitfaden zu Pflege und Reinigung im Abschnitt „Support“ auf der Astro-Website.

Per mantenere questo prodotto nelle sue migliori condizioni, consultare la nostra guida per la manutenzione e la pulizia nella sezione dedicata all'assistenza del sito Web Astro.

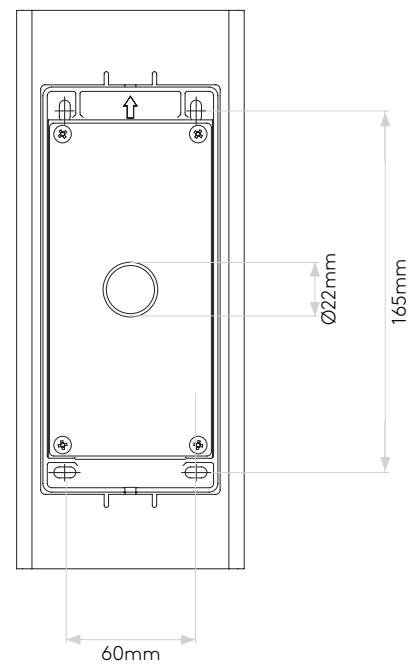
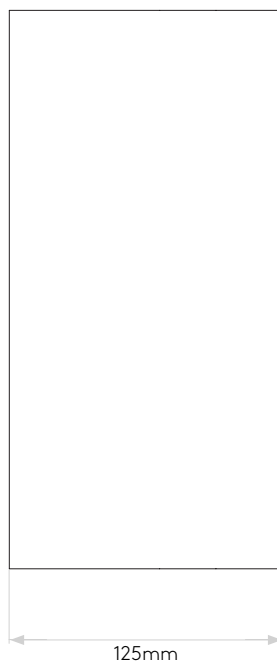
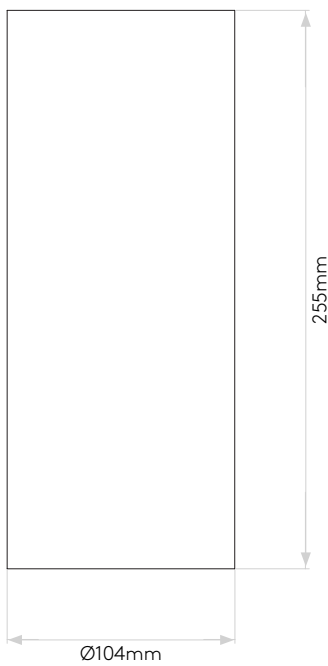
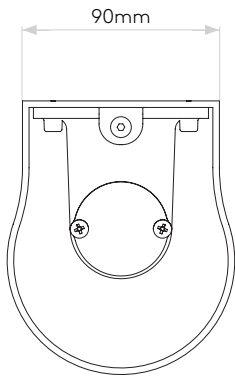

Please note that some dimensions may vary slightly due to manufacturing tolerances, this includes cable entry and fixing holes

Veuillez noter que certaines dimensions peuvent varier légèrement en raison des tolérances de fabrication, y compris l'entrée de câble et les trous de fixation.

Bitte beachten Sie, dass die Maße Fertigungstoleranzen unterliegen und daher in geringem Umfang von der angegebenen Größe abweichen können. Dies gilt auch für Kabeleingänge und Befestigungslöcher.

Si prega notare che possono esserci piccole variazioni in alcune dimensioni dovute alle tolleranze di produzione, queste includono l'ingresso del cavo e i fori di fissaggio.